

KINGSAT KM-X6/X8

Installation and Operation Manual

Table of Contents

1. Introduction	1
1.1 Introduction of KINGSAT KM-X6/X8	1
1.2 Features of KINGSAT KM-X6/X8.....	2
2. Installation	3
2.1 Preparation.....	3
2.2 Planning the Installation	4
2.3 Installation and Mounting of Antenna	6
2.4 Installing the ACU	10
3. Operation Instruction.....	14
3.1 Introduction.....	14
3.2 Operating the ACU.....	15
3.3 Error Code and Solutions	25
4. Preparation for Transportation	26

1.INTRODUCTION

1.1 Introduction to KINGSAT KM-X6/X8

KINGSAT KM-X6/X8 is a digital satellite antenna system. It's designed for all types of vessels to automatically search, track and capture satellite signal from the Digital Video Broadcasting (DVB) compatible satellites.



Figure 1: Maritime Satellite TV Antenna KM-X6



Figure 1: Maritime Satellite TV Antenna KM-X8

1.2 Features of KINGSAT KM-X6/X8

Strong Signal Receiving performance

Using self-made LNB and RF processing components, which offers the best reception quality and maximum antenna performance.

Fast Satellite Search and Position

An integrated GPS antenna allows for the antenna control system to update the GPS date automatically for accurate positioning and faster satellite locking.

Excellent Anti-Heavy Sea Tracking Ability

Proprietary algorithm, advanced mechanical design, embedded GPS and high-sensitive gyro enable always-lock connectivity and worldwide deployment.

Expendable Worldwide Satellite Library

The ACU is installed with Worldwide satellite database and can be easily revised or expended manually.

Easy-to-install Aesthetic Design

Simple installation and setup design with aesthetic maritime white of environment-resistant feature save labor and maintenance costs.

2. Installation

2.1 Preparation

Standard components

Antenna Unit*1
Antenna Control Unit(ACU)*1
24V/3A Adapter for ACU*1
Hex head bolt, Spring washer, Flat washer, Nut, Mounting bracket, Tapping screw
Cables: 15 meters coaxial cable*2 Power cable*1

Tools Required for Installation(Not included in the standard package)

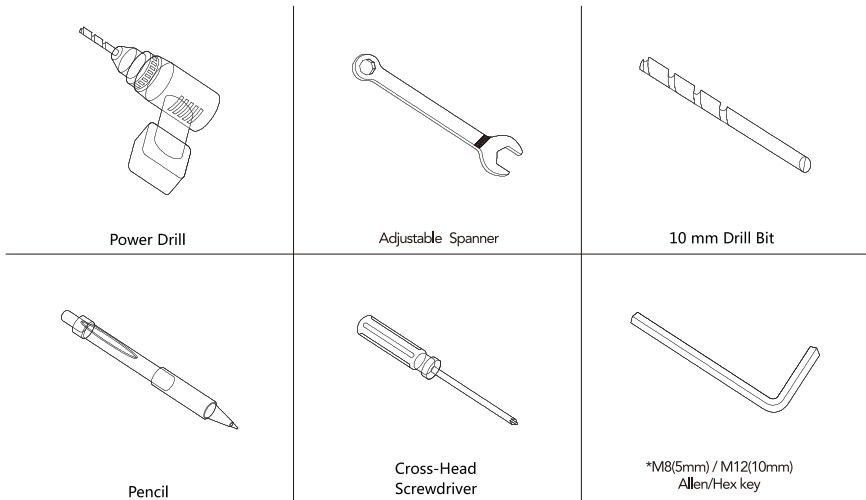

Figure 3: Required Tools for Installation

2.2 Planning the Installation

Antenna Unit

Install the antenna in accordance with the following procedures to ensure maximum performance of the antenna.

The antenna must be installed at the position:

- (1) It has an all-around clear view of the horizon.
- (2) There are no obstacles within 1 degree above the antenna.
- (3) Far away from the Radar.

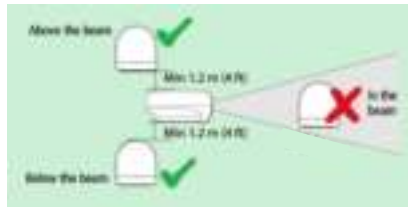

Figure 4: Position of Radar and Antenna

- (4) The mounting platform should be firm enough and not subjected to excessive vibration.

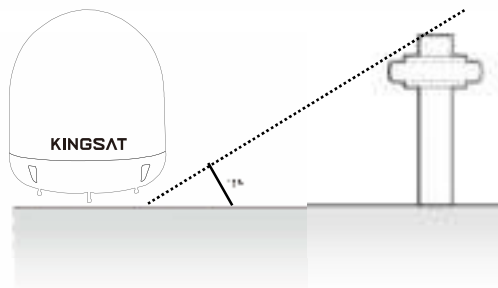

Figure 5: Elevation Limit of Obstacles

Cables

Cables must be routed correctly. Before installing the system cables, consider the following points:

- (1) All cables need to be well clamped and protected from physical damage and exposure to heat and humidity.
- (2) Do not bend cables excessively.
- (3) Where a cable passes through an exposed bulkhead or deckhead, a watertight grommet or swan neck tube should be used.

Power Requirement

Follow the power requirement to avoid damage to the system. KINGSAT KM-X6/X8 has been designed to work on a boat which power supply is in the range of 110-240V AC.

RF Cable

This cable is supplied at a length of 15m. If longer length is required you should replace this cable with an extended RF cable supplied by Earda Technologies.

Note: Exceeding the indicated cable length will result in reduced performance of your system.

2.3 Installation and Mounting of Antenna

The method of installation and mounting of antenna may be due to vessel design but the following procedures are applicable in most situations, and will result in a secure and effective installation.

Confirmation of Size Prior to Installation

- (1) Check the height and diameter of the bottom surface of the antenna before installing.
- (2) The space must be sufficient for installing the antenna unit considering the height and diameter of the antenna.
- (3) The height and the diameter of the bottom surface of the antenna are as shown in the following drawings.

Note: Before installing the antenna, open the radome and remove the shipping constraints from the antenna interior.



Figure 6: Radome Dimension of KM-X6



Figure 6: Radome Dimension of KM-X8

Confirmation of the Antenna Mounting Position

Referring to the mounting template, mark where antenna will be mounted on board (it must be a flat surface) or on a separate power tower.

Note: Exposed cable must be protected because an exposed cable may cause electric shock and cause serious damage to the equipment.

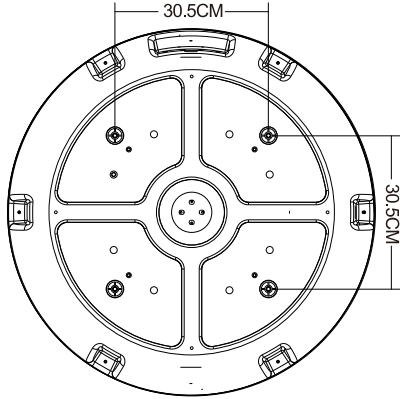

Figure 8: Mounting Hole Position of KM-X6

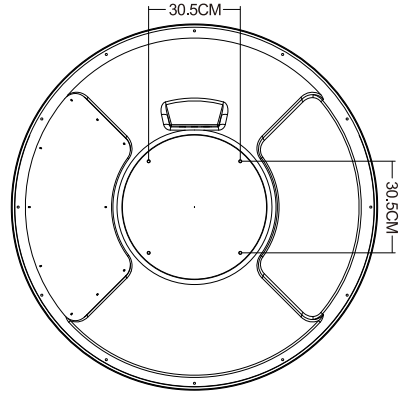

Figure 9: Mounting Hole Position of KM-X8

Connection of the Cable

Remove the rubber cap from RF connector. Connect the RF cable to the RF connector at the bottom of the base plate through the access hole using an adjustable spanner. Be careful not to over tighten and damage the connector.

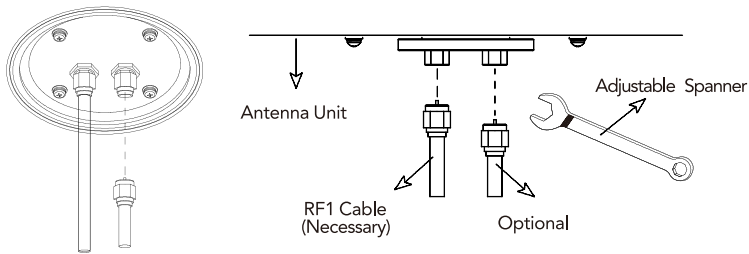

Figure 10: Connectors on Bottom of Antenna

Note: Do not tighten excessively when using the spanner, it will damage the threads. Be careful that the connectors do not touch the mounting surface of the antenna, it might cause a critical malfunction and serious damage to the equipment.

Mounting the Antenna

Before mounting the antenna, you must remove the four fixing bolts on the antenna. (The fixing bolts are used to fix the rotating part of the antenna to prevent damage during transportation.)

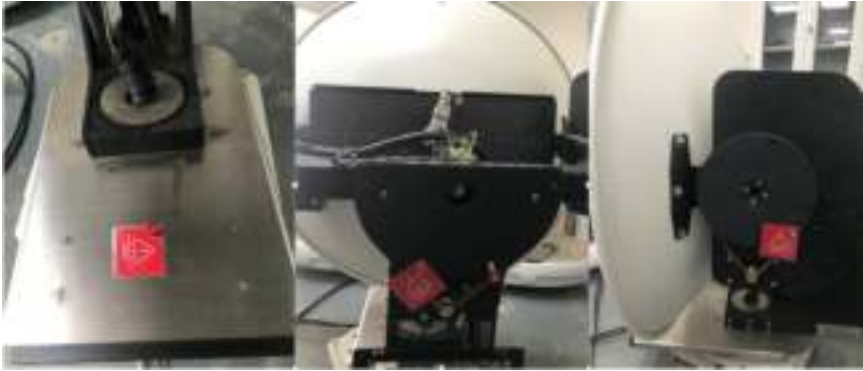

Figure 11: Fixing bolts

Attach the antenna by using the hex head bolts, spring washers, flat washers and nut supplied. There are two different ways for different models:

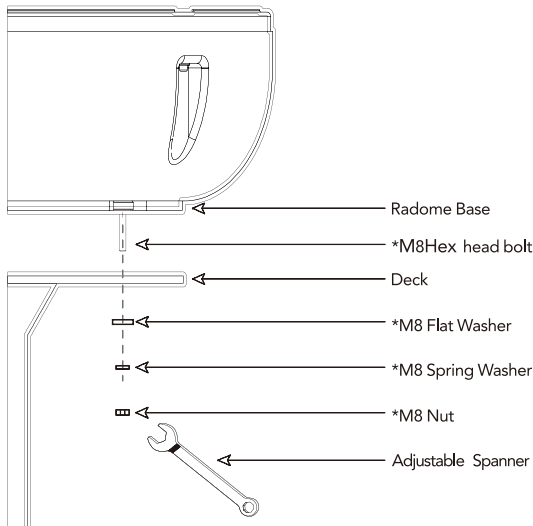

Figure 12 : Mounting the Antenna Model 1

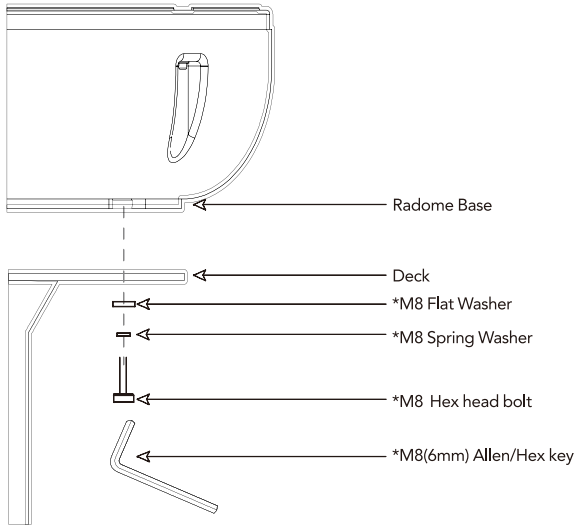

Figure 12 : Mounting the Antenna Model 2

2.4.Installing the ACU

ACU Dimension

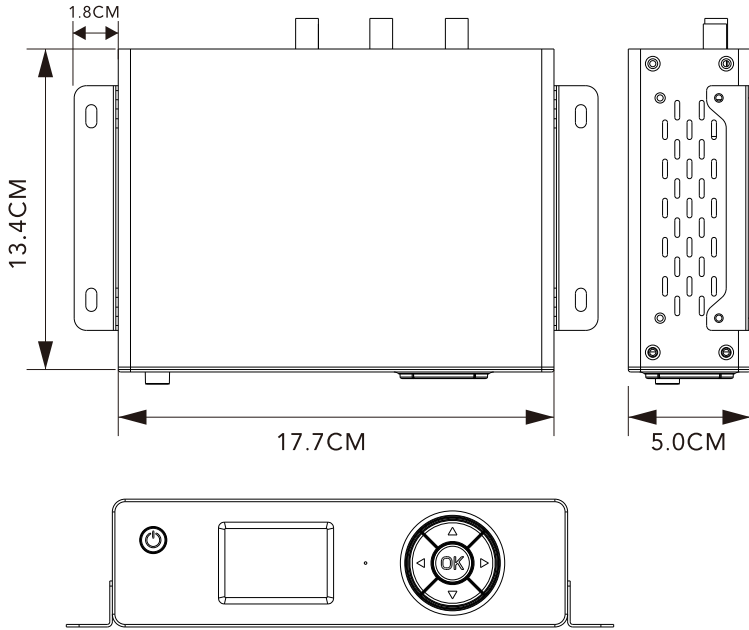

Figure 13: Dimension of ACU

Selecting ACU Installation Site

The ACU should be installed below deck, in a location that is:

- (1) Dry, cool, and ventilated.
- (2) Easy accessed from your main TV viewing area.

Selecting ACU Installation Site

The ACU should be installed below deck, in a location that is:

- (1) Dry, cool, and ventilated.
- (2) Easy accessed from your main TV viewing area.

Installing the ACU

- (1) The ACU should be installed using the two supplied mounting brackets which are allowed for a top or bottom mounting configuration.
- (2) Using the self tapping screws supplied, attach the mounting brackets to both sides of the ACU.
- (3) Place the ACU in the location where it is going to be installed.
- (4) Connect the cables to the rear of the ACU.
- (5) Use a pencil to mark the position of 4 holes (two on each side), and use the appropriate drill bit to drill.

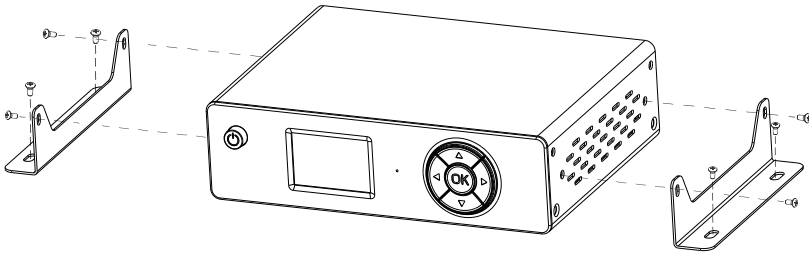

Figure 14.1: Installation of ACU

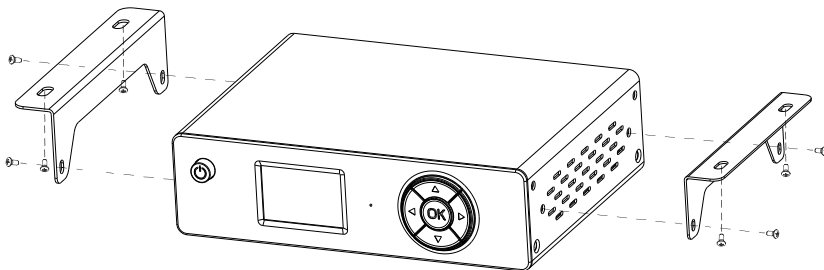

Figure 14.2: Installation of ACU

Connecting the System Cables of KM-X6/X8

After installing and mounting the antenna, connect the ACU to the antenna. Refer to the drawing shown below to connect cables.

Cable Connection

- (1) Connect "RF1" on the antenna base plate to "ANT-RF1" on the ACU.
- (2) Connect "RF2" or "RF3" or "RF4" on the antenna base plate to Receiver.

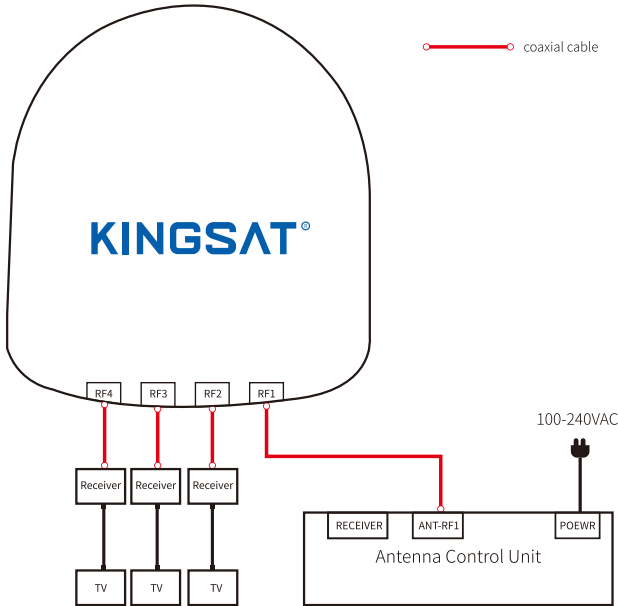

*Receiver is not included in the standard package

Figure 15: Cable Connection Configuration

Multi-STBs Connection

In order to connect multi-Receivers to the antenna, you need to purchase a suitable Multi Switch. The Multi Switch has to be installed between the antenna unit and the Receivers as shown in the following diagram.

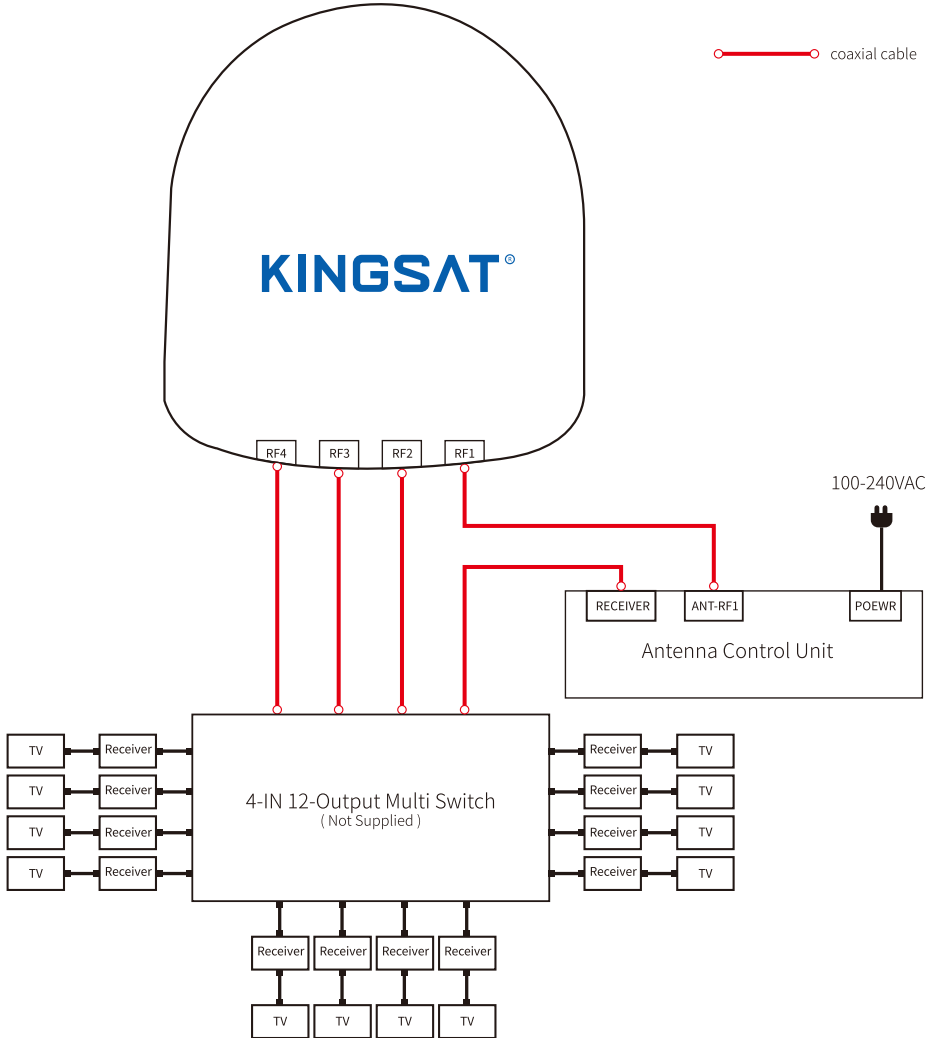

*Multi Switch and STBs are not included in the standard package.

Figure 16: Multi-Receivers Solution

3. Operation Instruction

3.1 Introduction

This section of the Manual describes how to setup your Satellite TV System using the ACU. It includes the following functions:

Note: Many of the above functions will only be required after first installation of your system. Refer to the User Manual before operating the system.

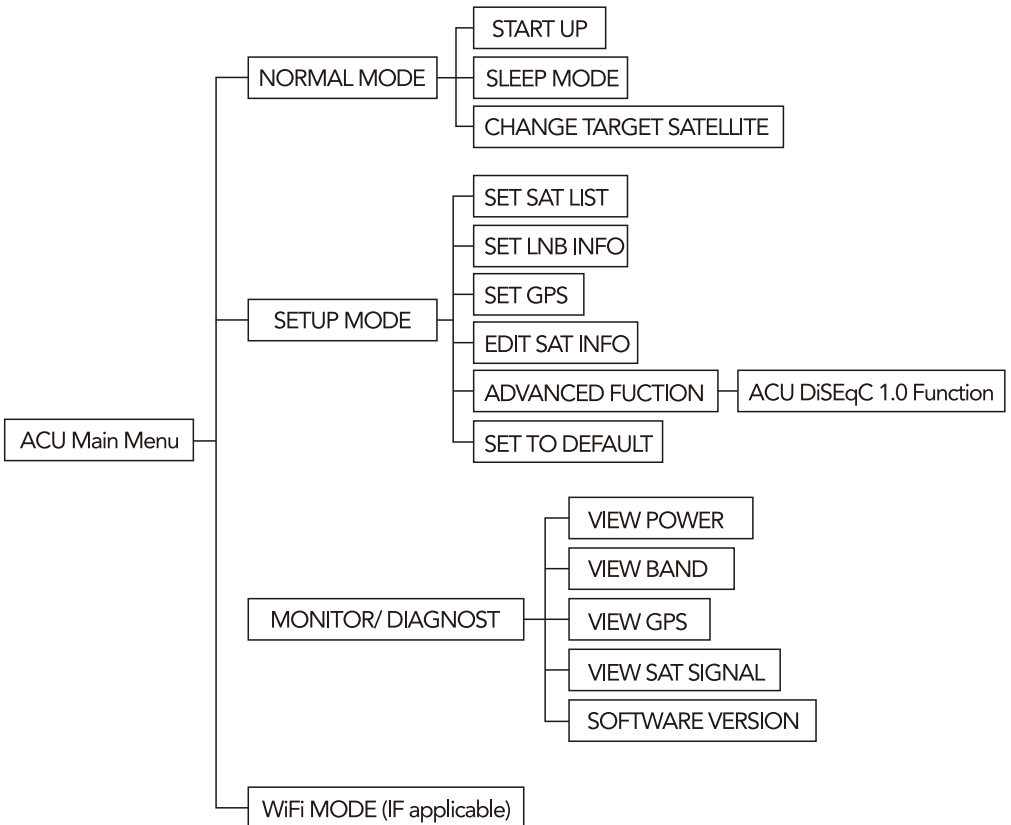

3.2 Operating the ACU

ACU Soft Keys

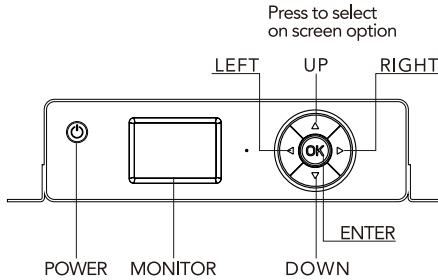
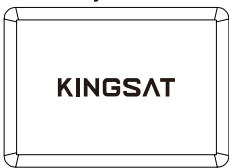

Figure 14: ACU Soft Keys

NORMAL MODE

START UP

With the system installed and power applied, the ACU screen will show the following sequences:



1. Press POWER and the brand will be shown on MONITOR.

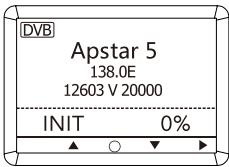

2. Data communication is being established between the antenna and the ACU. The ACU and antenna are initialized.

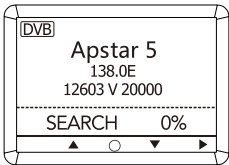

3. The antenna is searching for Pre-set satellite.

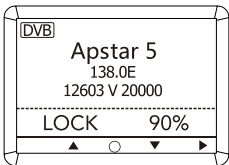

4. The antenna has locked the satellite and is now tracking.

Note: The operation method is the same for KM-X6/X8. The following instruction will be described using KM-X6 as an example.

SLEEP MODE

The antenna will fall into sleep mode when it doesn't lock satellite for 8 minutes. It will wake up automatically after 10 minutes or changing target satellite automatically.

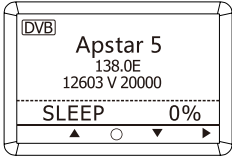

CHANGE TARGET SATELLITE

The antenna is pre-programmed with up to 6 satellites as default mode.

You can change your target satellite easily and the antenna will track it automatically.

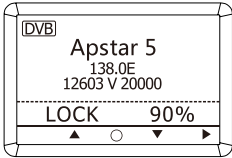

1. On homepage, press OK to enter SATELLITE SELECT mode.

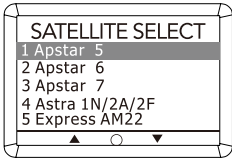

2. Press UP ▲ or DOWN ▼ to select your target satellite.
Press OK or wait for 3 seconds when you finished selecting.

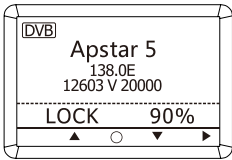

3. The antenna will search and track target satellite automatically.

SETUP MODE

SET SAT LIST

You can change the Pre-programmed satellites.

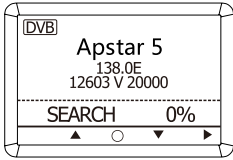

1. On homepage, press RIGHT ► to enter SETUP MODE.

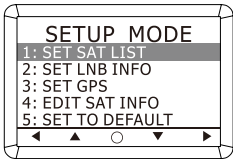

2. Select SET SAT LIST and press OK.

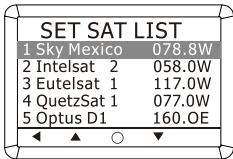

3. Set SAT 1: Select SAT 1 and press OK.

Then you can press LEFT ◀ or RIGHT ▶ and press OK to set chosen satellite as SAT 1.

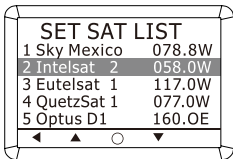

4. The method shown above is same for setting SAT 2, SAT 3, SAT 4, SAT 5 and SAT 6.

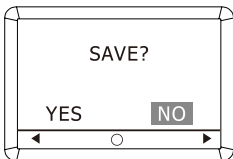

5. Press LEFT ◀ to enter save mode.

Press YES to save the input information.

Press NO to cancel and return to SETUP MODE.

2.SET LNB INFO

You may set the LNB information in this mode. But it is not recommended for a novice satellite service user to use this mode.

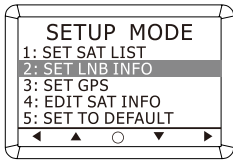

1.Select SET LNB INFO and press OK.

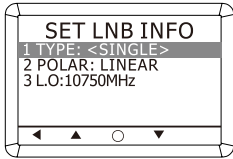

2.You can select "UNIVERSAL" or "SINGLE" in TYPE.

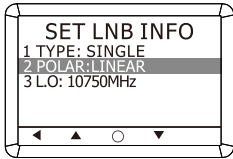

3.You can select "LINEAR" or "CIRCULAR" in POLAR.

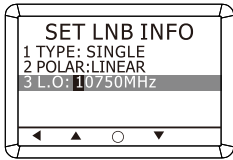

4.Input the local frequency (HIGH or LOW) of LNB.
UP ▲ Increases the value. DOWN ▼ Decreases the value.
Change ◀▶ the flashing digit with LEFT or RIGHT.
Modify the value of frequency and press OK.

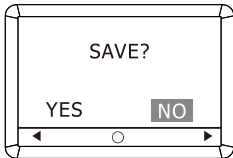

5.Press ◀ to enter save mode
Press YES to save the input information.
Press NO to cancel and return to SETUP MODE.

LNB Type for reference:(Others not shown in below this list, please contact Kingsat technician for further information)

SINGLE: Single Band LNB
Asia-11300MHz
American-11250 MHz
Japan-10678MHz
Korea-10750 MHz

UNIVERSAL: Universal LNB
Low band local frequency -9750 MHz
High band local frequency-10600MHz

3.SET GPS

It is possible to set up and modify the GPS information, which enhances the antenna functionality and positioning performance.

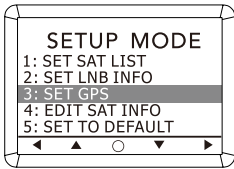

1.Select SET GPS and press OK.

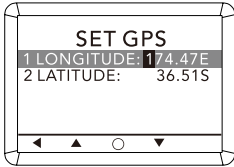

2.Select LONGITUDE and press OK to modify the value of longitude.

UP ▲ Increases the value. DOWN ▼ Decreases the value.

Change ◀▶ the flashing digit with LEFT or RIGHT .

Modify the value of frequency and press OK.

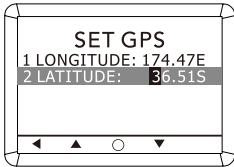

3.The method shown above is same for modifying the value of Latitude.

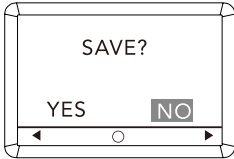

4.Press LEFT ◀ to enter save mode.

Press YES to save the input information.

Press NO to cancel and return to SETUP MODE.

4.EDIT SATELLITE INFO

It is possible to modify the existing satellite information and input new satellite information into the ACU as well. It is not recommended to setup in this mode for a user who is unwell-known of satellite parameter.

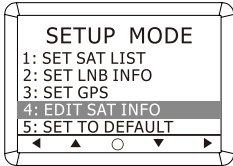

1.Select EDIT SAT INFO and press OK.

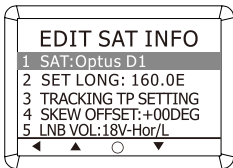

2.Select SAT and press OK to set satellite with LEFT ◀ or RIGHT ▶ .

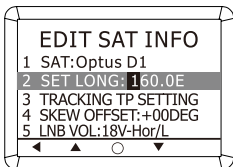

3.Select SET LONG and press OK to set satellite's Longitude. UP ▲ increases the value.DOWN ▼ decreases the value. Change the flashing digit with LEFT ◀ or RIGHT ▶ . Modify the value and press OK.

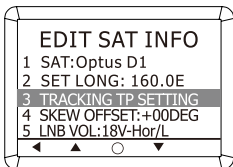

4.Setup tracking frequency, Select TRACKING TP SETTING and press OK.

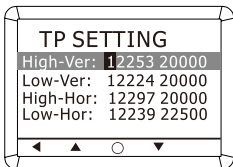

5.Input four kinds of tracking TP parameter frequency(MHz) and symbol rate(K/s) as list shows
High-band Vertical tracking TP --- High-Vert
Low-band Vertical tracking TP --- Low-Vert
High-band Horizontal tracking TP --- High-Hor
Low-band Horizontal tracking TP --- High-Hor

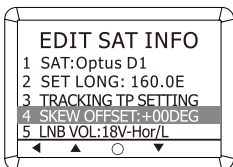

6.Select the degree of SKEW OFFSET(+00DEG is recommended).

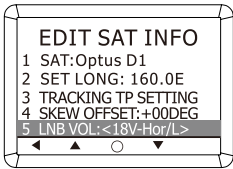

7. Select the Voltage Supply Method to LNB.

18V-Hor/L --- This item means LNB voltage is selected with 18V, and matched polarization is that Linear- Horizontal ,Circular -Left.

13V-Ver/R --- This item means LNB voltage is selected with 13V, and matched polarization is that Linear- Vertical ,Circular -Right.

Bypass --- This item means LNB voltage is followed with the setting of receiver which is connected with ACU, and matched polarization is same as receiver. In case that no receiver connects to ACU, it will select **13V-Ver/R** by default.

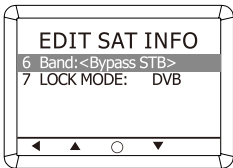

8. Select the High/Low band Method.

OK-LowBand --- This item means select Low band which is only for universal LNB. If Single L.O LNB, this selection does not affect anything.

22K-HighBand --- This item means select High band which is only for universal LNB. If Single L.O LNB, this selection does not effect anything.

Bypass --- This item means selection of LNB L.O (only for universal LNB) is followed with the setting of receiver which is connected with ACU. In case that no receiver connects to ACU, it will select **OK-Low** by default.

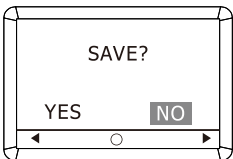

9. Press LEFT ◀ to enter save mode.

Press YES to save the input information.

Press NO to cancel and return to SETUP MODE.

5.ACU DiSEqC 1.0 Function (Additional version)

Kingsat ACU with additional version can support DiSEqC 1.0 which is protocol between receiver and ACU that easily switch 1-4 satellite from receiver DiSEqC 1.0 command.

Before setup , ACU Satellite list must be lined up by 1-4 which are matched with DiSEqC 1.0 port1-port 4 from receiver. Enable ACU DiSEqC 1.0 function, must follow below step.

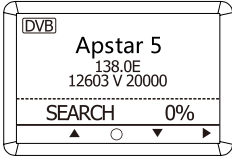

1.Hold on Left button ◀ 3 seconds in main menu,then go into ADVANCED FUNTION page.

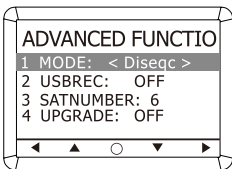

2.Press OK button in Mode item, select DiSeq,then press OK button.

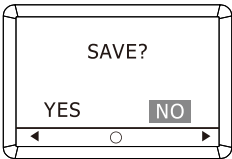

3.Press Left button ◀ , Save this setting.

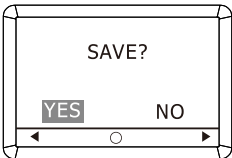

4.Select YES, SAVE done

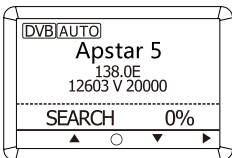

5. Come back to main menu, AUTO icon appears which means enable DiSEqC 1.0 Function.

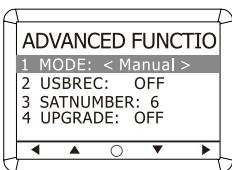

6.Disable this DiSEqC 1.0 function. Hold on Left button 3 seconds in main menu,then go into ADVANCED FUNTION page. Select Manual in Item MODE, then this function closes.

6.SET TO DEFAULT

It is possible to reset all the parameters back to the default setting in this mode.

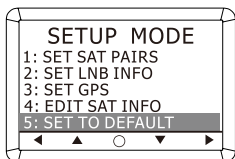

1. Select SET TO DEFAULT and press OK.

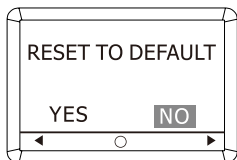

2. Press YES to reset all the parameters to default.
Press NO to cancel resetting to default.

MONITOR/DIAGNOST

The antenna status can be checked by reviewing the results of the diagnostic self-test of the antenna. Refer to the following codes to understand the test results.

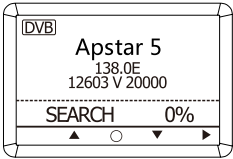

1. On homepage, press **RIGHT** ► twice continuously to enter MONITOR/DIAGNOST mode.

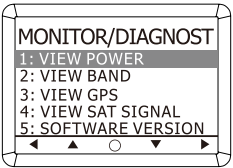

2. POWER status is displayed. Select VIEW POWER and press OK to check the status of POWER.

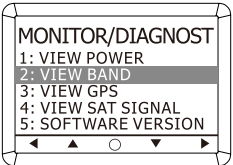

3. Select VIEW BAND and press OK to check the status of 0/22K.

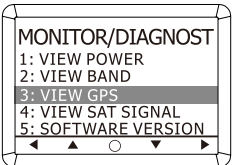

4. Select VIEW GPS and press OK to check the status of GPS.

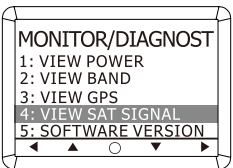

5. Satellite Signal status is displayed.

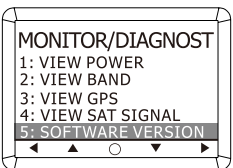

6. Software Version is displayed.

3.3 Error Code and Solutions

- E01 The initialization of Antenna control board failed.
- E02 Antenna Input Power is tested. If failed, check the RF cable.
- E03 Skew System is tested. If failed, check the control board, skew motor.
- E04 Tuner is tested. If failed, check the tuner and cable connection.
- E05 LNB is tested. If failed, check the LNB and control board.
- E06 Gyro board is tested. If failed, check the gyro board, cable connection.
- E07 EL axis is tested. If failed, check the limit sensors, motor and belt for EL axis.
- E08 AZ axis is tested. If failed, check the limit sensors, motor and belt for AZ axis.

4. Preparation for Transportation

This is to describe how to prepare the antenna internally for transportation.

The following procedures to secure the antenna shall be strictly observed to protect it from being damaged during transportation.

- (1) Rotate antenna left and right slowly until the limit switch is pressed.
- (2) Turn the antenna by 360° to the reverse direction.
- (3) Insert the shipping foams in front of the dish and back side of the pedestal to secure the pedestal in position with the bottom radome.
- (4) Cover upper part of radome. Be careful not to touch the reflector when assembling upper part of radome.
- (5) Pack KINGSAT KM-X6/X8 into the original package box.



Figure 18 :
Fixing Azimuth bolt

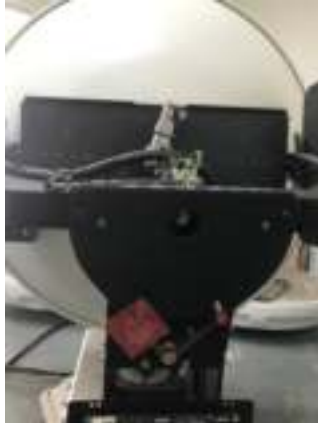

Figure 19 :
Fixing Elevation bolt



Figure 20 :
Fixing Cross Level bolt

KINGSAT
Maritime Antennas

Address: Block A, 2 Jisheng Road , Nansha District,Guangzhou, PRC., 511455

Phone: +86-20-28662868

Web: www.kingsat-tech.com www.eardatek.com